

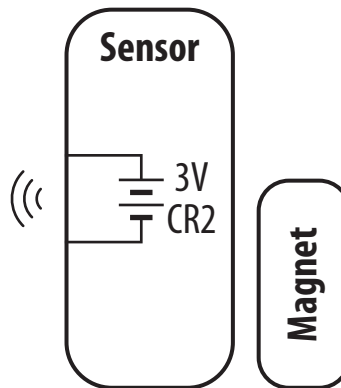















SW600

WIRING DIAGRAM



LEGEND

	Battery powered		Wireless communication
L, N	230V AC power supply		Pump
	Fuse		Valve actuator
COM, NO, NC	Voltage-free output		Temperature sensor
S, S1, S2	Input terminals		3-speed 230V AC fan
SL	230V AC voltage output		Light bulb or other load
	Contact normally open NO		Thermoelectric actuator
	Contact normally closed NC		Time programmer
	NC/COM/NO switch		External normally open contact
	Boiler - Boiler connection* - Boiler's contacts for ON/OFF thermostat (according to the boiler's instructions)		Transformer (voltage converter)